



Edge

d-control Edge ONE

Výcvikový obojek pro psy

Elektronisches Trainingshalsband
Electronic training collar
Collar electrónico de adiestramiento
Collier électronique de dressage
Elektromos tréning nyakörv
Collare elettronico di addestramento
Elektroniczna obroża treningowa

1. TRANSMITTER (HANDHELD DEVICE) – chapter 5.1

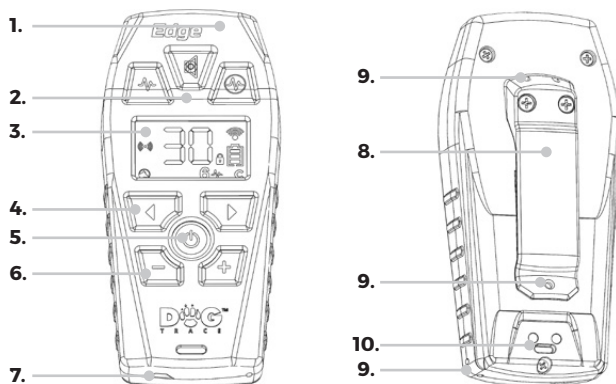

2. DISPLAY DESCRIPTION – chapter 5.2

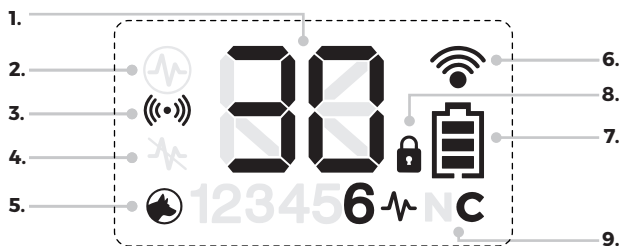

3. RECEIVER (COLLAR) – chapter 5.3

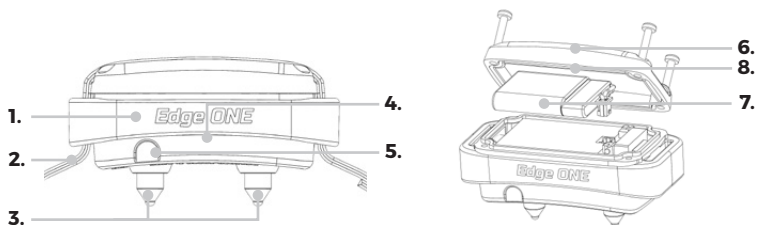

CONTENTS

1. Declaration of conformity	27
2. Important notices	27
3. ECMA	27
4. Package contents / optional accessories	27
5. Description of the device	28
5.1 Transmitter	28
5.2 LCD display	28
5.3 Receiver	28
6. Transmitter preparation	28
6.1 Charging the transmitter	28
6.2 Checking the battery level in the transmitter	29
6.3 Turning on/off transmitter	29
7. Receiver preparation	29
7.1 Charging the receiver	29
7.2 Checking the battery level in the receiver	29
7.3 Turning on/off receiver	29
7.4 Pairing the transmitter with the receiver	30
7.5 Pairing a second transmitter to the receiver	30
7.6 Choice of contact points	31
7.7 Fitting on the training collar	31
8. How to use the training collar - basic	32
9. Functions of transmitter	32
9.1 Acoustic signal	32
9.2 Short (N) / long (C) stimulation impulse	32
9.3 Optional booster / vibration button	33
9.4 Deactivating the function of stimulation impulse	33
9.5 Turning off the vibration response of the transmitter	34
9.6 Secure lock of setting button	34
10. For best results	34
10.1 Maximum range between transmitter and receiver	34
10.2 Use of training collar in winter period	35
11. Troubleshooting	35
12. Maintenance	36
13. Technical specification	36
Warranty card	96



manual in other
languages **online**

dog training
basic commands



1. DECLARATION OF CONFORMITY



The manufacturer VNT electronics s.r.o. declares that the Dogtrace d-control Edge Electronic Training Collar complies with the Council of Europe Directive 2014/53/EU and conforms to all applicable standards. For more information, please visit www.dogtrace.com.

2. IMPORTANT NOTICES

- Please read the instructions carefully before use. Keep the instructions for future use.
- The d-control electronic training collars are intended for animal training only. It is forbidden to use the training collars in such a way, which may cause injury, pain or fear to the animal.
- Do not use the electronic training collar on dogs that are not in good physical condition (e.g. heart problems, epilepsy, etc.) or have behavioural problems (aggressive dogs, etc.).
- Do not leave the collar on the dog for more than 12 hours a day. Prolonged exposure of the contact points to the dog's skin can cause skin irritation. If this happens, do not use the training collar until all signs of irritation have disappeared.
- Do not use a collar with an electronic receiver to walk on leash or restrain your dog. The contact points would put excessive pressure on the dog's neck or the receiver box could be mechanically damaged. In case of any problems and for further advice, do not hesitate to contact a professional trainer.
- Do not place the transmitter near objects that are sensitive to magnetic fields, as permanent damage may occur.
- Both the receiver and the transmitter contain a rechargeable Li-Pol battery. If the battery is not used, it must be recharged every 12 months. Protect the batteries from damage caused by sharp objects and high temperatures, as they can catch fire or explode. Do not use any batteries other than the original batteries.
- Dispose of used batteries in a designated place.
- A person with a cardiac support device (pacemaker, defibrillator) must take appropriate precautions. d-control emits a static electromagnetic field.

3. ECMA

VNT electronics s.r.o. is an active member of the ECMA (Electronic Collar Manufacture Association), which represents the highest quality manufacturers of electronic training aids for dogs. The aim of all members of the association is to develop and produce quality and reliable training systems that respect the safety of the animal. For more information visit www.dogtrace.com or www.ecma.eu.com.



4. PACKAGE CONTENTS / OPTIONAL ACCESSORIES

Contents of the package

- Transmitter (handheld device)
- Receiver (collar) with strap
- Cable with clip for charging - 2 pieces
- Set of contact points - 2 pcs 7 mm, 10 mm
- Clip for hanging the transmitter on the belt incl. 2 screws
- Lanyard for hanging the transmitter on the neck
- Test glow lamp
- Instructions for use

Optional accessories

- Contact points 7/10 mm
- Replacement seal for receiver
- Woven/plastic straps in various colours
- Mains adapter 5.2 V / 1A

5. DESCRIPTION OF THE DEVICE

5.1 Transmitter (Fig. 1 on page 2)

1. Integrated antenna
2. Command buttons
3. LCD display
4. Buttons for selecting the dog
5. Off/on button
6. Buttons for adjusting the level of stimulation
7. Red mark indicating the magnet for fastening the collar
8. Belt clip
9. Holes for the lanyard on the neck
10. Contacts for charging

5.2 LCD display (Fig. 2 on page 2)

1. Stimulation impulse level
2. Adjustable button function - booster
3. Adjustable button function - vibration
4. Stimulation impulse deactivated
5. Choice of dog
6. Command transmission indicator
7. Battery status indication
8. Secure lock of setting buttons
9. Long (C) / short (N) stimulation impulse

5.3 Receiver (Fig. 3 on page 2)

1. Integrated antenna
2. Strap
3. Contact points
4. Indication lights
5. Red mark for magnet attachment (collar on/off)
6. Battery compartment cover
7. Li-Pol battery
8. Seals

6. TRANSMITTER PREPARATION

6.1 Charging the transmitter

The Edge ONE transmitter contains a Li-Pol rechargeable battery. It must be charged before first use.

1. Remove any dirt from the charging contacts. Connect the power cable to the transmitter using the clip.
2. Connect the mains cable to a 5 to 5.5 V DC charging adapter (not included) and then plug it into the socket.
3. Lines will gradually appear in the battery symbol on the display.
4. The charging time is about 2 hours.
5. The battery is charged when the full battery symbol is displayed - see below.

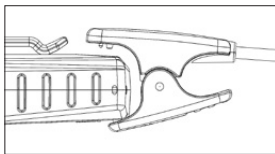





WARNING: Charge the battery in an environment with a temperature between 0° and 40°C. For charging, use a charging adapter with a voltage between 5 and 5.5 V DC or the original 5.2 V mains adapter offered by the manufacturer as an optional accessory. Using an adapter with a higher voltage could damage the electronic collar.

6.2 Checking the battery level in the transmitter

The battery status of the transmitter is indicated by the battery symbol on the LCD display.

6.3 Turning on/off the transmitter

Press the button  for 1 second to switch the transmitter on or off.

Battery status	Transmitter
100%	
60%	
30%	
10%	

7. RECEIVER PREPARATION

7.1 Charging the receiver

The Edge ONE receiver contains a Li-Pol rechargeable battery. The battery must be charged before using the device for the first time.

1. Remove any dirt from the charging contacts. Connect the mains cable to the device using the clip. The tabs on the charging clip must fit into the slots on the collar housing.
2. Connect the mains cable to a 5 to 5.5 V DC charging adapter (not included in the scope of delivery), which you then connect to the mains.
3. The orange indicator light on the device lights up (charging time is approx. 2 hours).
4. When the charging process is complete, the orange indicator light goes out.

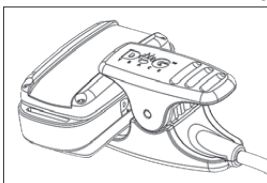

WARNING: Charge the battery in an environment with a temperature between 0° and 40°C. To charge, use a charging adapter with a voltage between 5 and 5.5 V DC or the original 5.2 V mains adapter offered by the manufacturer as an optional accessory. Using an adapter with a higher voltage could damage the electronic collar.

7.2 Checking the battery level in the receiver

The battery indication lights (LEDs) on the side of the receiver are used to check the battery in the receiver (see Figure 3/4 on page 2).

If the red LED flashes, the collar is empty and needs to be recharged. Do not leave the Edge ONE in a discharged in a discharged state for an extended period of time. The battery could be damaged.

Battery status	Receiver
100%	Green indicator light
35%	Simultaneous green and red indicator light
20%	Red indicator light

7.3 Turning on/off receiver

A magnetic switching system is used to switch the receiver on/off, which is activated by attaching a magnet. The magnet is located at the bottom of the transmitter marked with a red target .

Switching on:

1. Place the red mark on the transmitter against the red mark on the receiver - the red indication light will illuminate, followed by the green indication light.
2. When the green light comes on, move the transmitter away from the receiver. The green light will start flashing.

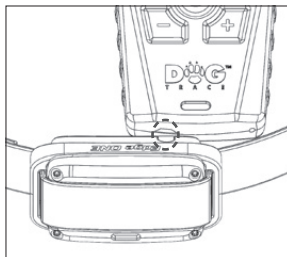

Switching off:

When switching off, follow the same procedure as when switching on the receiver.

1. Place the red mark on the transmitter against the red mark on the receiver - the green indicator light will illuminate, followed by the red indicator light.
2. When the red light comes on, move the transmitter away from the receiver. The receiver will stop flashing.

IMPORTANT: When switching on/off, simply hold the transmitter target against the receiver target for approximately 1 second. If you hold the targets together for more than 5 seconds, the receiver will go into transmitter-receiver pairing mode. This mode is indicated by the alternating flashing of the green and red indicator lights. If this occurs, follow the steps in the 7.4 Pairing the transmitter with the receiver.

7.4 Pairing the transmitter with the receiver

In order for the transmitter (handheld device) to communicate with the receiver (collar), they must be paired together. When you buy a set of d-control receiver and transmitter, there is no need to pair - the set is already paired from the factory. Pairing is required when you buy another collar or a new transmitter. Up to six collars can be paired to one transmitter and two transmitter can be paired to one collar at the same time.

First, you must set the desired number of positions on the transmitter for pairing the collars:

1. Simultaneously long press the ◀ and ▶ buttons and the currently set number of positions will flash on the display.
2. Use the + / - buttons to set the desired number of positions for pairing the collars you want to use on the transmitter.
3. Confirm your selection by short pressing the ⏻ button.

Use the buttons ◀ / ▶ to select between collar positions (depending on the settings - collar 1 to 6). Now you can start pairing the collars with the transmitter. The collar you want to pair **must be switched off**.

4. Use the ◀ / ▶ buttons on the remote control to select the position to which you want to pair the collar.
5. Place the red mark on the bottom of the transmitter against the red mark of the receiver for 5 seconds (similar to switching on the receiver - see the illustration in chapter 7.3). The red indicator light will come on, followed by the green indicator light.
6. After 5 seconds, the green and red indicator lights will flash alternately.
7. Now press the ⏻ button on the transmitter.

To pair other collars, simply use the ◀ / ▶ buttons to select a different position on the remote control and repeat the procedure from step 5.

NOTE: The collar will only stay in pairing mode for 15 seconds. If the green and red lights stop flashing alternately before you press the ⏻ button, you must repeat the pairing procedure - point 5 to 7. Pairing can be done at a limited distance between the transmitter and the collar (up to approximately 3 m).

7.5 Pairing a second transmitter to one receiver

On one receiver can be paired 2 transmitters (remote controls) and one receiver can have two positions on one transmitter. The collar to which you want to pair the second transmitter **must be switched on**.

1. Use the ◀ / ▶ buttons to select the position on the transmitter to which you want to pair

the collar.

- Place the red mark on the bottom of the transmitter against the red mark on the receiver for 5 seconds (similar to switching on the receiver - as shown in chapter 7.3). The green indication light will come on, followed by the red indication light.
- After 5 seconds, the green and red indication lights will flash alternately.
- Press the  button on the transmitter.

WARNING: In case you do the collar pairing according to chapter 7.4 - the collar is turned off before the pairing starts, the paired second transmitter is automatically deleted from the collar.

TIP: 2 positions on one transmitter can be paired to one collar according to the procedure in chapter 7.5. This feature can be used to call multiple dogs with one command at the same time - for example, I have 5 dogs paired to positions 1 to 5. On position 6 I can pair all 5 dogs according to the procedure in chapter 7.5 and thus I can call all dogs at the same time by pressing one button.

7.6 Choice of contact points

To ensure the transmission of stimulation impulses from the receiver to the dog's skin, stainless contact points are used. Each package contains two types. If your dog has short hairs, use the short contact points. If you have a dog with longer or thicker hairs, choose the longer contact points. Screw the contact points onto the receiver - see Figure 3/3 on page 2. Tighten the contact points by hand. Do not use pliers or other tools to tighten, you may cause irreparable damage to the product.

TIP: If your dog's hairs is too long, it is possible to use contact points with a length of 12/17/21 mm. If the dog has dry skin, it is option to lubricate the skin where the contact points touch the skin, with medical vaseline, moisturizing oil, etc. This will ensure better transmission of the stimulation impulses.

7.7 Fitting on the training collar

The strap (collar) on which the receiver is attached must be tightened to ensure good contact between the contact points of the receiver and the dog's skin. It is recommended to put the collar on when the dog is in standing position. The collar with the receiver is properly tightened if you can put 2 fingers between the collar and the dog's neck. If the dog has long or thick hair, it is advisable to cut the hair where the contact points touch the skin or choose a longer type of contact points.

WARNING: If the collar is too loose, the receiver is likely to move and repeated rubbing may irritate your dog's skin. even more, reliable contact of the contact points with the skin surface is not assured and thus proper function of the training collar is not assured. We do not recommend leaving the collar on you dog for several hours in the same place, as it could cause skin irritation. If your dog needs to wear the collar for long periods of time, change the position of the receiver on the neck regularly. A collar with a receiver that is overtightened can cause blisters on the skin where the contact points touch. If this happens, do not use the training collar until all signs of irritation have disappeared.



8. HOW TO USE THE TRAINING COLLAR - BASIC

- An important prerequisite for using a training collar is the trainer's basic knowledge of dog training.
- If you do not have this knowledge, we recommend that you contact a training centre, kennel club or dog school to learn basic communication with your dog.
- You can start using the collar with a six-month-old puppy that has already completed the basic training "SIT", "DOWN", "STAY" or at least "FUJ", "DON'T"...
- Require these commands on him along with the sound signal from the training collar so that he makes the connection between them.
- A command should always be followed by a reward or at least a praise so that the dog likes to follow your commands and grows in the desire to please you.
- You must not take the command for granted and punish disobedience - the dog will soon lose interest in you.
- If you are not sure that your dog will obey the call, start training on a tracking line, for example.
- Your dog will need to get used to the collar; let your dog wear the collar for a few days, but do not use it so that he does not immediately see the correlation between the collar and the effects.
- Positive and effective training takes time - take your time!
- Choose a familiar environment, a place your dog is used to.
- Choose the right moment to press the button - at the exact moment when your dog is doing something wrong.
- In case of any problems and for further advice, do not hesitate to contact a professional trainer.

9. FUNCTIONS OF TRANSMITTER

Before using the command button  /  /  you must first use the  /  buttons to select the collar 1 to 6 to which you want to send the command.

9.1 Acoustic signal

The receiver on the dog's collar starts to emit an acoustic (sound) signal. This command can precede the stimulation impulse and is a very effective warning. The acoustic signal can be used instead of the command TO ME / TO THE LEG, in this case it replaces the whistle, whose volume is always perceived by the dog in the same way. It is very important to always use the acoustic signal in the same way so as not to confuse the dog.



9.2 Short (N) / long (C) stimulation impulse

This function allows the receiver to activate corrections in the form of safe stimulation impulse transmitted by two contact points.

The meaning of the stimulation impulses is not to hurt the dog. The impulse is very unpleasant to the dog and therefore he will soon make the connection between the oral command, the acoustic signal and the unpleasant feeling in his neck. These stimulation impulses will be kept to a minimum over time, as the dog will associate them very well with disobeying your command.

The red indication light on the receiver illuminates while the stimulation impulse is being emitted.

Stimulation level selection

It is important to choose the correct intensity of the stimulation impulse for your dog, therefore it is finely adjustable in 30 levels. Because every dog is differently sensitive, it is impossible to estimate the correct level of impulse in advance. Use the  /  buttons on

the remote control to set the impulse level. Start at the lowest levels. If your dog does not respond to a low level of stimulation, gradually increase it until you see a slight response. The stimulation impulse should never cause pain or fear in your dog.

Switching short / long stimulation impulse

Short N (NICK) – the stimulation impulse is only 0.5 seconds long, regardless of the button holding time.

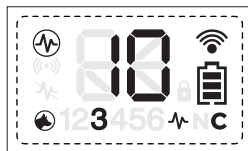

Long C (CONTINUES) – the receiver emits a stimulation impulse until you keep pressing the button on remote control, but for safety reasons the maximum length is limited to Eight seconds.

To switch from a long **C** to a short **N** stimulation impulse, you must set the impulse to level 0 using the **=** button. Then by pressing **=** repeatedly it will start to change from **C** to **N** and vice versa. After the desired **C/N** setting, use the **+** button again to set the desired stimulation impulse level.











9.3 Optional booster /vibration button

The optional button can have a preset booster function or vibration function.

The booster function allows you to preset a different level of stimulation impulse (usually 3 to 5 degrees higher) than you have set on the  button. This function can be used to solve crisis situations when the dog does not respond to the standard command .

The vibration function is particularly useful for attracting the attention of sensitive dogs or for training dogs with hearing problems. It provides a discreet call to the deaf. Provides the ability to disturb the dog from unwanted activity using the element of surprise. Each vibration mode can mean a different command.



Optional button settings:

1. Use the  /  buttons to select the collar for which you want the button  to set.
2. Long press and hold one of the buttons to select the dog  or . The dog number and the previous setting will flash.
3. To select the vibration, press **=** repeatedly until you reach level 0. Letter "V" (vibration) will be displayed instead of 0.
4. If you want to have a booster function on the  button, use the **+** / **=** buttons to select the level of stimulation impulse you want to have set on this button.
5. A short press on the  button will return you to the main screen.
6. To check (only when you don't have a collar on your dog), press the optional button  and the display will show the current setting (either V or the level set for the booster function).

9.4 Deactivating the function of stimulation impulse

In case you do not want to use the stimulation impulse functions and have a collar with only acoustic (sound) and vibration correction, the impulse functions can be completely deactivated.

The deactivation of the stimulation impulse is set separately for each paired collar.

1. Use the  /  buttons to select the collar for which you want to deactivate the stimulation impulse.
2. Repeatedly press the **=** button on the transmitter to set the stimulation impulse to level 0.
3. After setting level 0, press the **=** button again and hold for about 3 seconds. On the display of transmitter you will see the symbol .

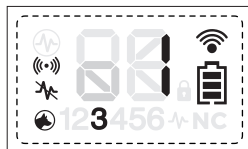

In this mode, the function of the  and  buttons changes to the vibration function. Different types of vibration can be set for the  button using the **+** / **-** buttons:

Level	Type of vibration
1	1 vibration
2	2 vibration
3	3 vibration
4	Intermittent vibration



The button  has a vibration function while the button is held down.

To return to classic mode with the stimulation impulse option, select vibration level 1 with the **-** button and then hold the **-** button for 3 seconds. The transmitter will vibrate briefly and the stimulation impulse function will be activated.

9.5 Turning off the vibration response of the transmitter

The transmitter is in the factory set to vibrate when the buttons are pressed. To disable this function, long press and hold the **-** and **+** buttons simultaneously. The transmitter will vibrate briefly. Follow the same procedure to activate the vibration response.

9.6 Secure lock of setting button

The setting buttons can be locked to prevent accidental pressing. To lock/unlock, quickly double-click the  button. When locked, the  symbol will appear on the display - Figure 2/8 on page 2.

10. FOR BEST RESULTS

10.1 Maximum range between transmitter and receiver

The maximum range between transmitter and receiver is affected by a number of factors - weather, terrain, vegetation, etc. To ensure maximum range of the device:

- Do not cover the antenna on top of the transmitter.
- Hold the transmitter vertically away from your body and with your arm extended above your head when transmitting the command.
- Check the battery in the transmitter and receiver and replace it if necessary.

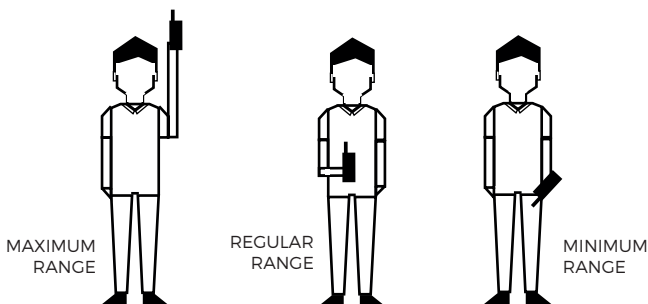

10.2 Use of training collar in winter period

When using a training collar in winter, it is important to keep in mind:

- Low humidity - causes lower skin conductivity. Therefore, it is necessary to ensure better conductivity between the contact points of the receiver and the dog's skin. This can be achieved by lubricating the dog's skin where the contact points touch, for example with medical Vaseline, ointment or other skin moisturizer.
- Thicker dog hairs - when putting on the training collar, it is necessary to tighten the collar so as to ensure a permanent contact of the contact points with the dog's skin. If the coat is thick, it is advisable to cut the hairs where the contact points touch the skin, or choose a longer type of contact points.
- Change in battery features - when temperatures drop below 0 °C, the chemical reaction in the battery slows down. To ensure that the performance of the repetitive impulses (especially at higher levels) is maintained, we recommend inserting a new battery into the receiver for the winter period. During use, continuously monitor the dog's reactions and, if necessary, increase the level of the stimulation pulse by 1 to 2 degrees.

11. TROUBLESHOOTING

1. Read the manual carefully and doublecheck if the problem is caused by low batteries or improper use.
2. If the transmitter does not communicate with the receiver, try pairing the devices again - see chapter: 7.4 Pairing the transmitter with the receiver.
3. Your dog seemed unresponsive to stimulus:
 - Check again that the battery in the receiver is not low.
 - Test the functionality of the receiver using a test glove lamp (see Section 5 of this chapter).
 - Check that you have chosen the correct length of the contact points (chapter 7.6 Choosing the contact points) and that you have ensured contact with the dog's skin by tightening the collar (chapter 7.7 Putting on the training collar).
 - If the dog has dry skin, moisten it (Chapter 7.7).
4. Checking the correct function of the stimulation impulse:
The correct function of the short/long stimulation impulse command can be tested using the test glowe lamp.
 - Make sure the receiver is switched off.
 - Connect the pins of the test glowe lamp to both contact points - loosen the contact points, insert underneath the pins of the gland so that they hold firmly and tighten the contact points again (see picture).
 - Switch on the transmitter and receiver.
 - Press the button for the stimulation impulse. As the level of the stimulation impulse increases, the light of the test glowe lamp will increase.
5. If the problem persists, contact your dealer.

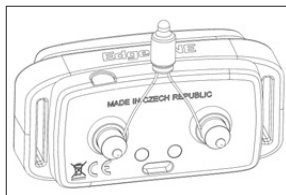

Location of the test glow lamp

12. MAINTENANCE

Never use chemical cleaners, solvents or volatile substances (thinner, petrol or other cleaners) to clean your d-control. Use a soft, damp cloth and, if necessary, a neutral detergent. The receiver (collar) is waterproof only if the seal is in good condition. To maintain watertightness, we recommend replacing the rubber seal under the receiver cap once a year. Also make sure to clean and adjust the seal properly after each battery change in the receiver and to tighten the screws properly. However, only tighten them with reasonable force! If you do not use the training kit for an extended period of time, remove the batteries from the device.

13. TECHNICAL SPECIFICATION

Transmitter

Range	250 / 450 m (depending on model)
Power	Li-Pol battery 530 mAh
Charging adapter	5 to 5.5 V / min. 500 mA
Battery life per charge	approx. 1 month
Frequency (power)	869.525 MHz (32/100 mW - depending on model)
Antenna	integrated
Coverage	water resistant
Operating temperature	-10 °C to +50 °C
Weight	91 g
Dimensions	108 x 50 x 23 mm

Receiver (collar)

Power	Li-Pol battery 200 mAh
Charging adapter	5 to 5.5 V / min. 500 mA
Battery life per charge	approx. 1 month
Antenna	integrated
Coverage	water resistant
Adjustable belt circumference	approx. 20 - 72 cm
Operating temperature	-10 °C to +50 °C
Weight	31 g (without strap)
Dimensions	55 x 27 x 21 mm